

Abgen

Trusted LED Supplier

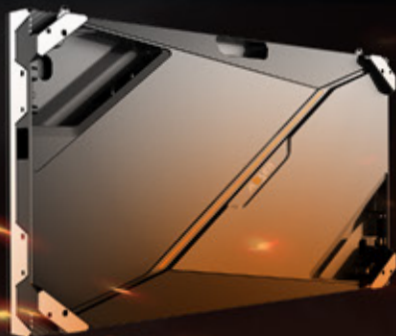

KL Series II

KL Series II

1.2mm | 1.5mm | 1.8mm | 2.5mm



16:9

Golden ratio



HFR+

High frame rate mode



800nits

Maximum brightness



X/Y/Z axis

Six-direction alignment



Fine Adjustment

Grayscale improvement technology



Color Precision

Color management technology



3840Hz

High refresh rate



**Dual receiving card &
dual power box**

Optional version

For all commercial display applications



Control rooms



Retail, shopping malls

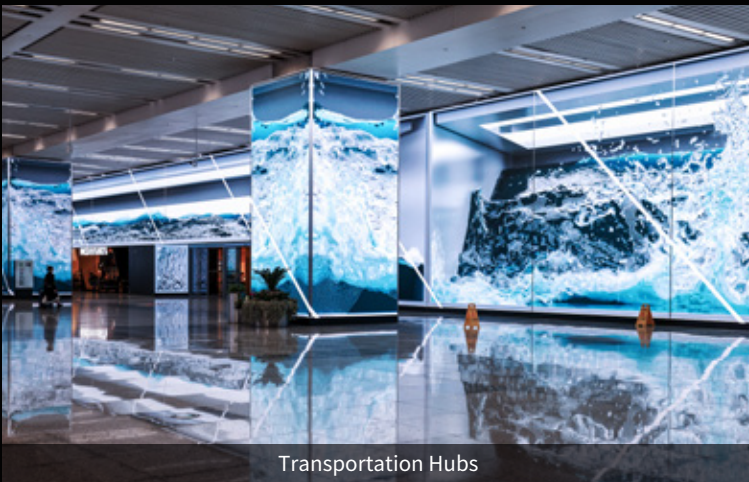

Transportation Hubs

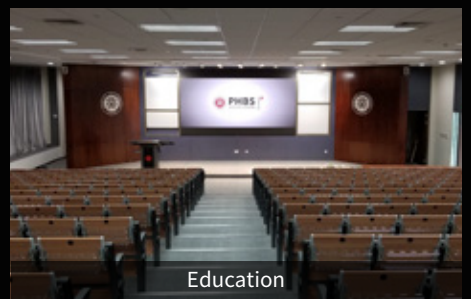

Education

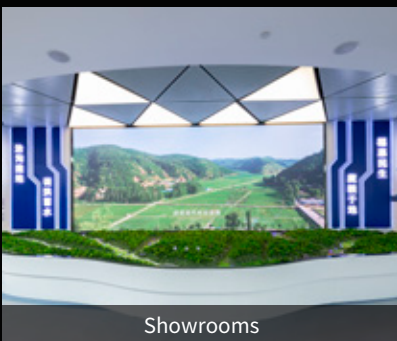

Showrooms



Enterprises



Conference Rooms

Ready-to-use panel with superior quality

Adopting the closed design, the panel contains high-quality power supply, receiving card and other components. Delivered in the form of ready-to-use panel, product quality is more guaranteed.

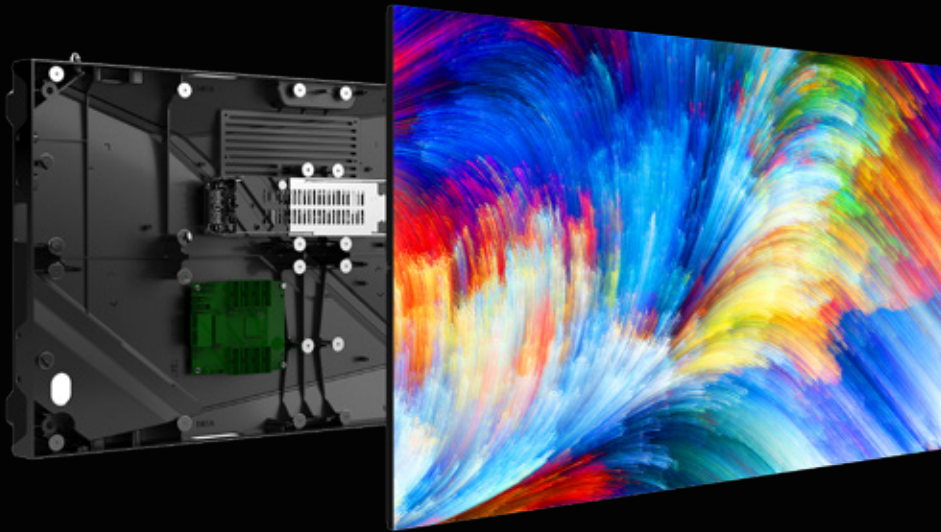

Fine die-casting
aluminum cabinet



High-performance receiving card



High-quality power box



Magnets with strong attraction force

Golden ratio brings better visual comfort

Based on ergonomic research, the panel adopts the golden ratio of 16:9 to enhance viewing comfort. It is also more suitable for playing mainstream videos.

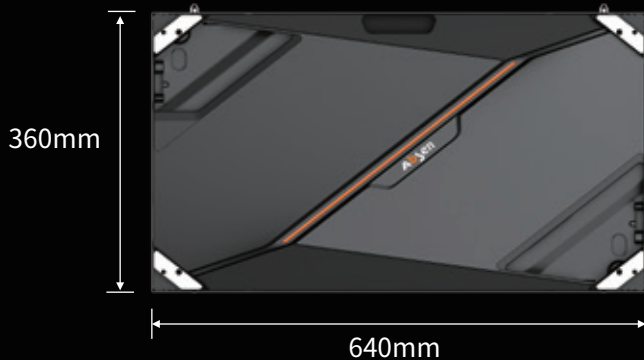

16:9

Panel size

The optimal aspect ratio for viewing
Mainstream video aspect ratio

Easily enjoy 8K vision display

72 panels can be spliced into a 16:9 screen to quickly achieve a 2K, 4K or even 8K display, making it especially suitable for use in places such as studios, command centers and conference rooms.

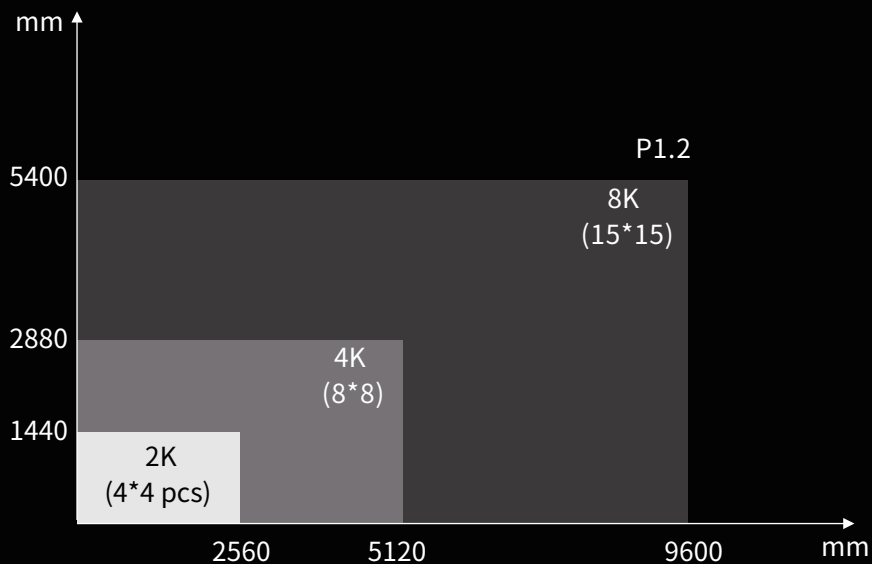

Fine Adjustment grayscale improvement technology

The grayscale performance is increased by four times, making the grayscale changes more naturally. Even under low brightness, it can perfectly display details even in the dark parts of the picture.



Fine grayscale, details visible in dark parts



Low grayscale, details lost in dark parts

Color Precision management technology

Intelligent adjustment is made through Color Precision management technology to match the color gamut range of the display with the source image. Highly reproduce natural scenes and achieve high-fidelity colors.



Original image



No color management, with color deviation

With color management, no color deviation

HFR+ mode for capturing the best moments

The KL II Series can support HFR+ mode* (120Hz high frame rate), smoothly display high-speed, quick-changing content and enhance visual fluency, making it especially suitable for playing high-speed motion pictures and 3D pictures.



*HFR: High Frame Rate

Ultra-low latency enables real-time image display

Reduces delays in transmission of video sources, synchronizes the display of real-time images and helps achieve live broadcasting with ease.



Sync to KL II series
Low latency

Sync to other displays
Significant latency

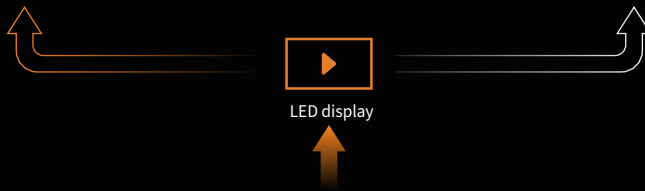

Live broadcast of transmitted computer images

Record exciting moments as you like

The brightness can reach up to 800nits, which greatly reduces the influence of ambient light on the display effect. Using PWM LED driver IC, the refresh rate is as high as 3840Hz, and there is no scan line when taking pictures.



Photo taken without scan lines



Photo taken with scan lines

Always keep the signal uninterrupted

Supports dual receiving cards and dual power boxes to ensure uninterrupted power supply and signal, so as to realize continuous transmission of information. This function is especially suitable for use in places such as control rooms and studios.

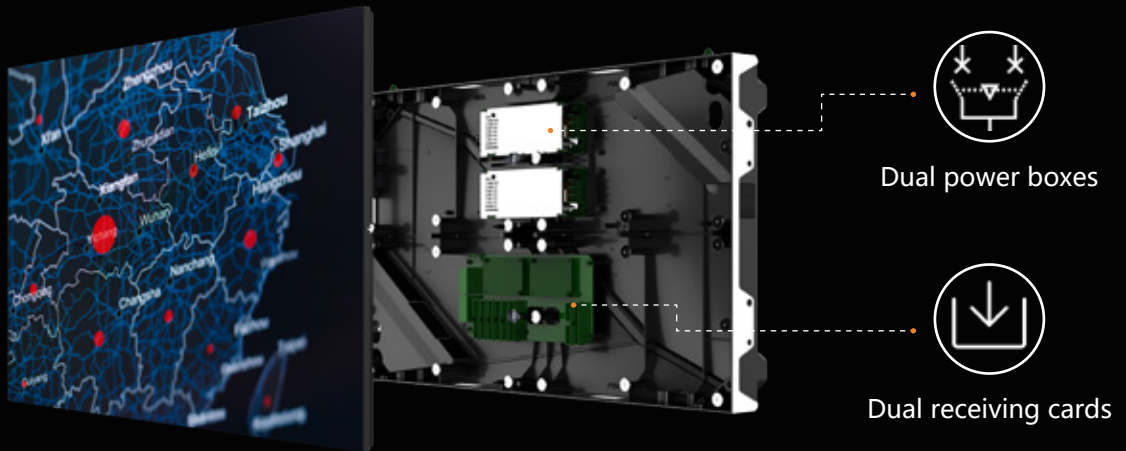

Control room



Studio

Multiple installation methods

The KL II Series supports hanging, wall mounting and stacking installation, etc. Hidden wiring design is adopted to make the installation more tidy. It supports six-direction alignment to improve flatness of the screen.



Stacking
installation



Wall-mounting
installation



Hanging
installation



Hidden wiring
design



Anti-collision
design



Quick
plug-in/out



X/Y/Z axis
alignment

Standard elegant accessories

Provide standard hanging bar and backing strip accessories to make installation easier.
Provide ultra-thin trim pieces solution to enhance aesthetic feeling in all directions.



- 640mm/1280mm hanging bar



- 2-in-1/ 3-in-1 backing strip



- Ultra-thin trim pieces

Easy and convenient front maintenance

Support front maintenance of module, receiving card and power box.
No need to build a dedicated maintenance channel, thereby saving installation space.



Module



Receiving card



Power box

Standardized quality control

It is manufactured in Absen's own factory through a standardized production process, and has obtained multiple certifications, allowing customers to use it without any worries.



Standardized manufacturing process

Every step of the production process is strictly managed to ensure product quality

Strict quality control

18 monitoring procedures
29 operating procedures
33 recording procedures
2,285 inspections and tests

Multiple certifications obtained, legal and compliant

Certified through CCC, China Energy Conservation Certification, etc.
Passed performance/ blue light hazard/ photobiology test, etc.,
which are recognized by CNAS accredited institution

Professional service, best experience

Absen has built up a global network , able to provide prompt and professional local services.

Absen service ability



Comprehensive support

Enjoy 2-year warranty, support up to 3-year extended warranty, lifetime maintenance, and enjoy 10+ items of professional service solutions to help you solve problems



Global coverage

400+ Absen certified partners, 2,400+ Absen certified engineers, covering most of the global market, the global service network is continuing to expand vigorously



Multiple service channels

Providing service via multiple channels such as Hot line, WeChat, WhatsApp, E-mail and official website to quickly take care of service requirements



24/7 response

24/7/365 available, quick response in 10 seconds



One-stop service

Enjoy exclusive and professional service in the whole process of pre-sales, sales and after-sales



Service channels

Hot line: +86 400-700-3278
WeChat: 13923413428
WhatsApp: 008613923413428
Email: service@absen.com
Official website: www.absen.com



Service time (GMT+8)

8:30~24:00: Staff service
00:00~8:30: Intelligent system service

Absen service philosophy

Initiative

Proactive care and return visits, regular touring inspection services for customers

Efficiency

Absen customer service center responds within 10 seconds, intelligently match the best local service resources, and enjoy a fast service experience

Standardization

Comprehensive service engineer training system, ACE professional training and certification, ACP professional certification; establishing customer's product files and record the entire service process

Thoughtfulness

Longer warranty, worry-free quality



Ready-to-Use LED

· Superior Quality / Worry-Free / Safe & Secure

Superior Quality

Excellent product design

Reliable raw material

Standard manufacturing process

Quality control throughout the whole manufacturing process

Extraordinary visual effect



VS

Inferior Quality

Crude product design

Poor raw material

Non-standard manufacturing process

No strict quality control

Terrible visual effect

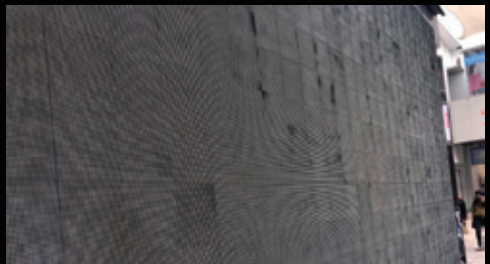

On-Site Assembly LED

· Inferior Quality/ Troublesome/ Hidden Dangers

Worry-Free

- Ready-to-use panel
- Quick installation
- One-stop standard solution
- Global service and long term warranty



Safe & Secure

- Safe and trustworthy
- Certification
- Professional installation & maintenance services



Troublesome

- On-site assembly
- Complicated installation
- Non-standard solution
- Unreliable after-sales service



Hidden Dangers

- Great security risks
- No certification
- Non-standard installation & maintenance services



Parameters

	KL1.2 II	KL1.5 II	KL1.8 II	KL2.5 II	
Physical parameters	LED type	Black SMD1010	Black SMD1212	Black SMD1515	Black SMD1515
	Pixel pitch (mm)	1.25	1.53	1.86	2.5
	Panel dimensions (W*H*D, mm)	640×360×65	640×360×65	640×360×65	640×360×65
	Panel resolution	512×288	416×234	344×192	256×144
	Panel weight (kg)	6	6	6	6
	Panel material	Die casting aluminum			
	Module size (W*H, mm)	320×180	320×180	320×180	320×180
Photoelectric parameters	Brightness (nit)	800	800	800	600
	Refresh rate (Hz)	≥3840	≥3840	≥3840	≥3840
	Grayscale (bit)	16	16	14	14
	Contrast ratio	4000:1	4000:1	4000:1	3000:1
	Color temperature (K)	3000~12000	3000~12000	3000~12000	3000~12000
	Viewing angle (H/V, °)	160/160	160/160	160/160	160/160
	Drive mode	1/32	1/52	1/43	1/32
	AC operating voltage (V)	200~240	200~240	200~240	200~240
	Power consumption (max./avg., W/m ²)	600/200	560/187	520/173	410/137
Application parameters	Storage temperature (°C)	- 40~ + 60			
	Operating temperature (°C)	- 10~ + 40			
	Storage humidity (RH)	10%~85%			
	Operating humidity (RH)	10%~80%			
	IP rating (front/ rear)	IP40/IP21			
	LED lifetime (h)	100000			
	Panel maintenance type	Fully front			
Panel installation type	Stacking/ wall-mounting/ hanging				

*Note: It is normal for the power consumption to fluctuate within ±15% due to the influence of the brightness of different batches of lamps. Please refer to the actual situation.

★ Shenzhen Absen Optoelectronic Co., Ltd. reserves the right to modify product design, specifications, and parameters without further notice. Photos are used for illustration purpose only as products may differ from these photos. All rights reserved by Shenzhen Absen Optoelectronic Co., Ltd.

Absen Optoelectronic Co.,Ltd

18-20F Building 3A, Cloud Park, Bantian Huawei Base, Longgang District Shenzhen, 518129, P.R.China
 T: +86-755-89747399 E: absen@absen.com
 F: +86-755-89747599 W: www.absen.com

Absen Inc.

7120 Lake Ellenor Drive, Orlando, Florida 32809, USA
 T: +1-407-203-8870 E: info@usabsen.com
 F: +1-407-203-8873 W: www.usabsen.com

Absen GmbH

Hessenring 4c, 64546 Moerfelden-Walldorf (Frankfurt am Main), Germany
 T: +49 (0) 6105 718941-0 E: europe@absen.com
 F: +49 (0) 6105 718941-29 W: www.absen-europe.com